

Legacy Series[®] & Weather Shield[®]

Premium Wood & Aluminum Clad Windows & Doors



Hinged Patio Door Parts Reference Catalog

Legacy Series 2-1/4" and Weather Shield 1-3/4" Doors
(includes LIFE  GUARD Series)
BY WEATHER SHIELD

For Hinged Patio Doors Produced After 2/02

#1177361 – 3/05

IMPORTANT

Some configured numbers in this catalog MAY NOT be active at the time of your order. CustomQuote™ software versions are updated regularly to accommodate new configured numbers. If a configured number is not active, please comment the part for ordering. Contact your Customer Relations Representative for assistance.

Weather Shield Mfg., Inc.



Individual replacement parts on following page.

SCREEN TRACK

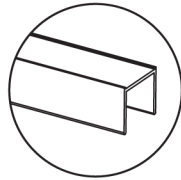

TOP RAIL GUIDE

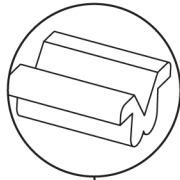

SCREEN ROLLER ASSEMBLY

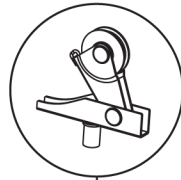

PILE WEATHER STRIP

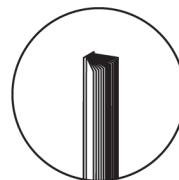

BUMPER

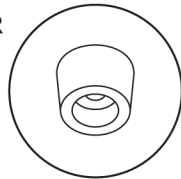

SCREEN KEEPER

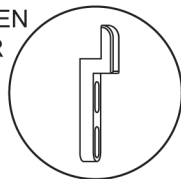

LATCH AND SPRING



HANDLES

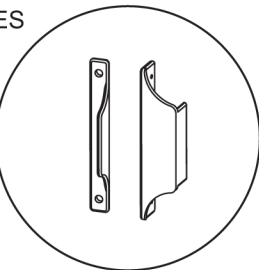

LATCH BUTTON

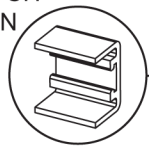

SCREEN MESH & FRAME

BLACK SCREEN SPLINE

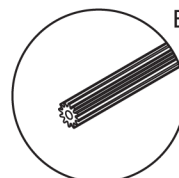



COMPLETE SLIDING SCREEN REPLACEMENT



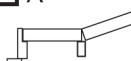

Specify the following:

1. Unit Call-Out Size _____
(See "Unit Call-Out Size" column on Pages 30-31 and Pages 19-20 for measuring information)

2. Finish _____
(See Page 34, Section 1, Item 3, "Exterior" for details)

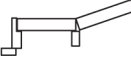
3. Screen Roller Assembly (See Page 39)
 Standard
 Stainless Steel

4. Door Hinge Code
 A B
 

E
 
 F
 

5. Screen Cloth
 Fiberglass
 Aluminum



Legacy Series® & Weather Shield®

Premium Wood & Aluminum Clad Windows & Doors

Center Hinged Patio Door

Replacement Parts
Sliding Screen

EXTERIOR SCREEN DOOR HANDLE ASSEMBLY BUBBLE PAK

Part Number
1170509

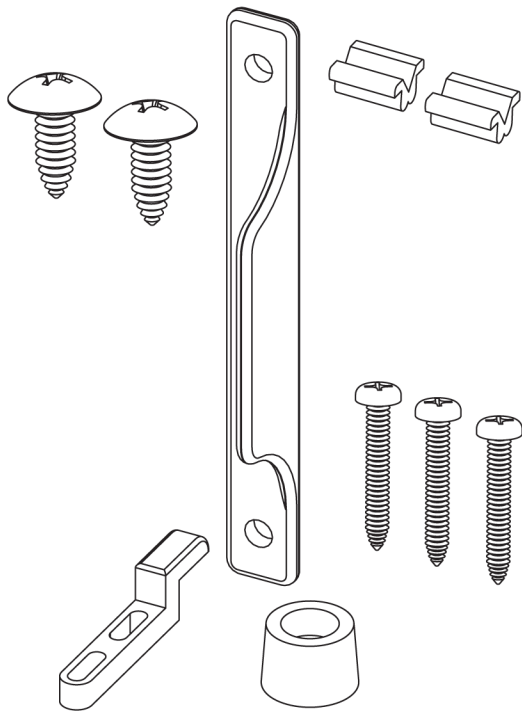

SCREEN HANDLE COMPLETE PAK

Part Number
940328

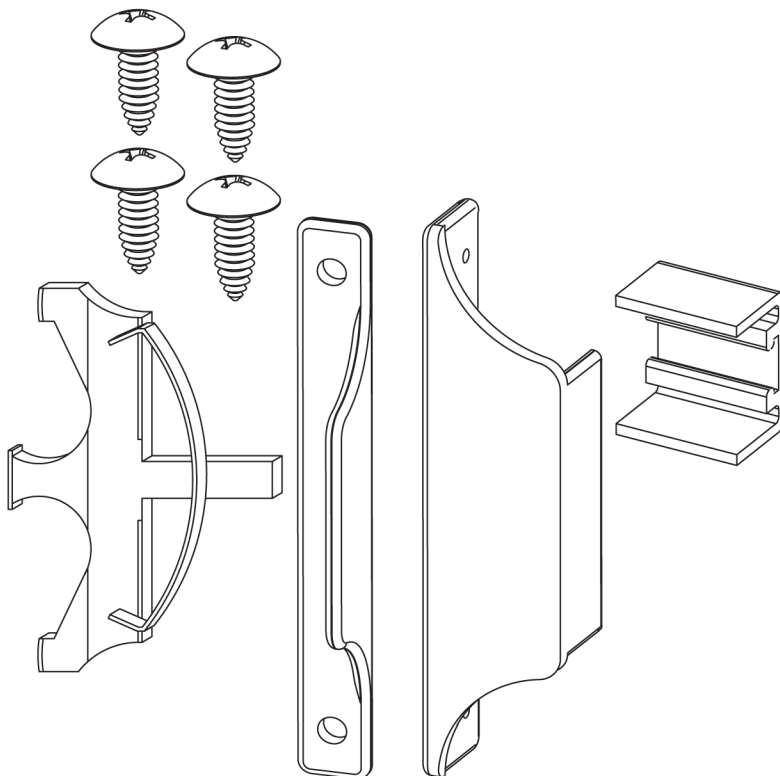

Pile Weather Strip



Configured Number
C979270

Screen Track



Configured Number
C968124

SCREEN KEEPER AND GUIDE PAK

Part Number
972594

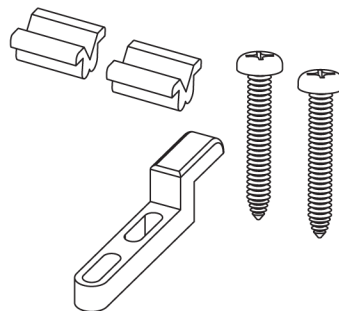

Black Screen Spline

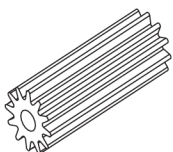

Extrusion Number
1018

Configured Number
C762782

Screen Roller Assembly

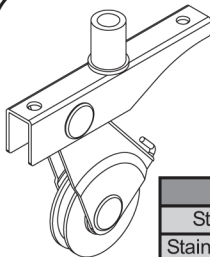

Part Numbers

Standard	972403
Stainless Steel	972893



Side Hinged Patio Door Hinged Screen Exploded View

Individual replacement parts on following page.

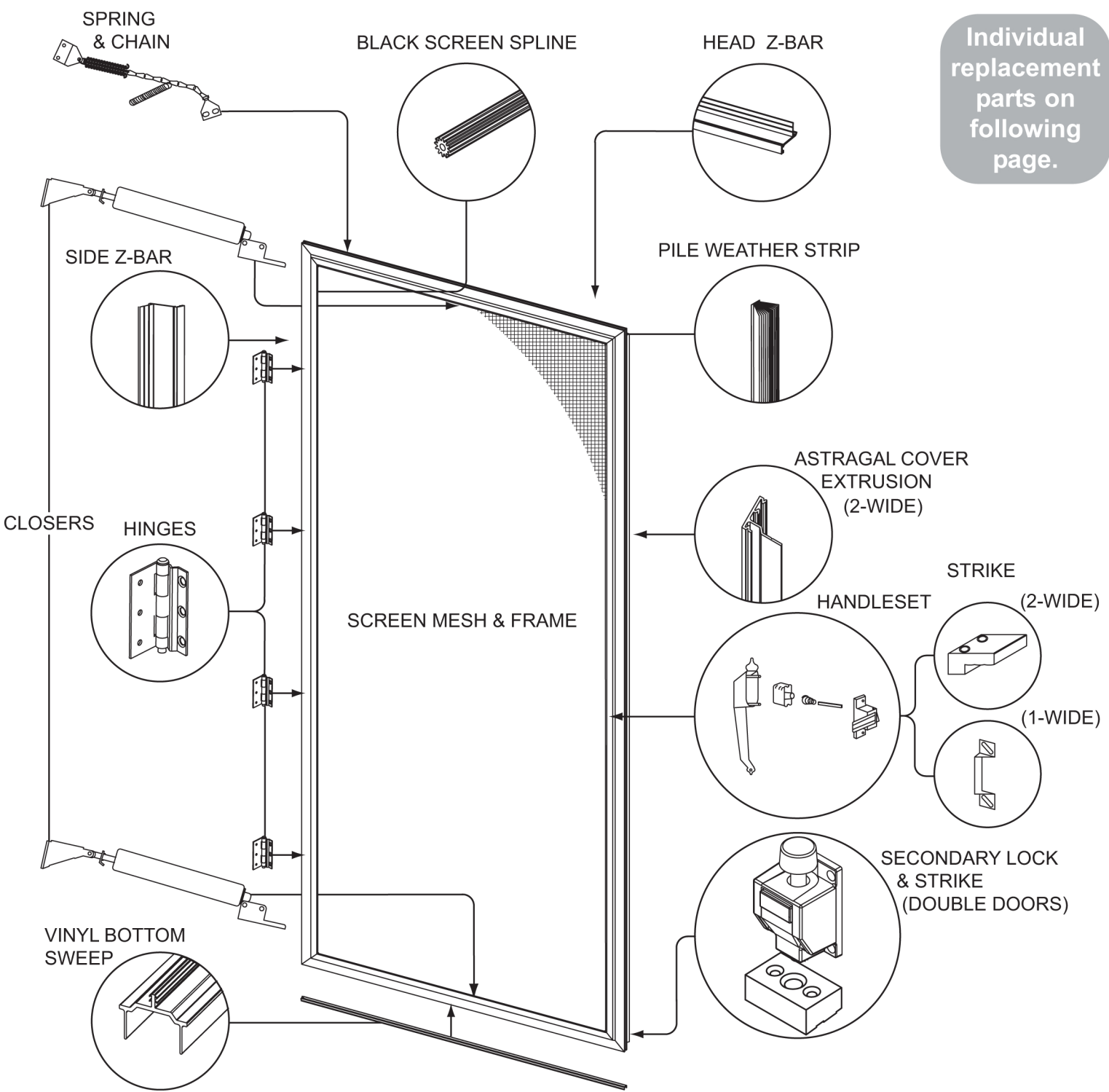

Specify the following: COMPLETE HINGED SCREEN REPLACEMENT

1. Unit Call-Out Size _____
 (See "Unit Call-Out Size" column on Pages 30-31 and Pages 19-20 for measuring information)

2. Finish _____
 (See Page 34, Section 1, Item 3, "Exterior" for details)

3. 1-Wide 2, 3, 4 Wide

4. Screen Cloth Fiberglass Aluminum

5. Jamb Depth 4-9/16" through 5-7/8" Jamb
 5-15/16" through 7-1/8" Jamb

6. Door Hinge Code:

<u>Hinge Code A</u>	<u>Hinge Code B</u>
<input type="checkbox"/>	<input type="checkbox"/>
<input type="checkbox"/>	<input type="checkbox"/>



HINGED SCREEN HARDWARE KITS (1-WIDE KITS SHOWN)

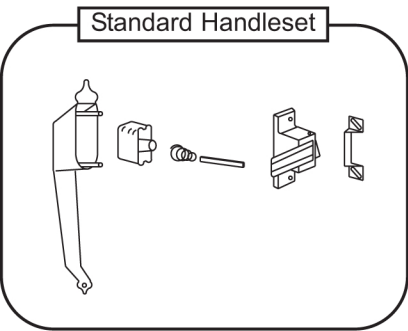

OR

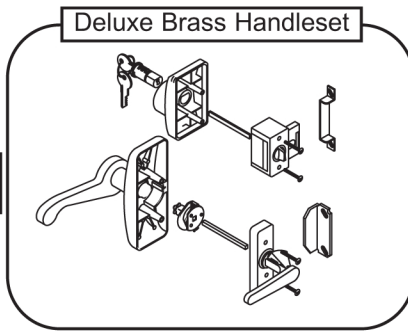

+

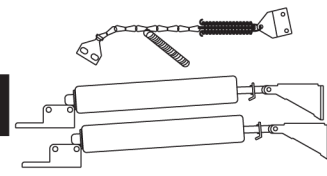

=

		Hardware Kit Part Numbers	
		1-Wide	2-Wide
STANDARD	White	940022	940036
	Black	940023	940037
DELUXE	White	940024	940038
	Black	940031	940039

Secondary Lock

(2 included in kit pictured above)

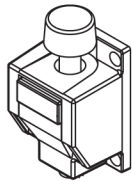

Part Numbers	
White	940020
Black	940021

2-Wide Strike

(2-Wide application only. Comes in place of strike in the kit pictured above)

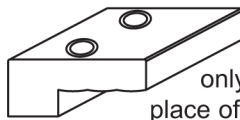

Part Numbers	
White	981755
Black	981756

These parts are included in the kit pictured above and may also be ordered individually.

Secondary Lock Strike

(2 included in kit pictured above)

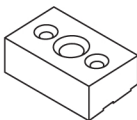

Part Numbers	
White	980794
Black	980792

Black Screen Spline

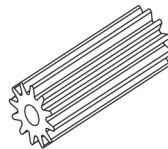

Extrusion Number	Configured Number
1018	C762782

Z-Bar Pile Weather Strip



Configured Number
C979089

Clad Doors
Head and Side

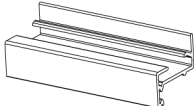

Extrusion Number
5638
Configured Number
C963465

Z-Bars

Wood Doors

Head Side



Extrusion Number
5576
Configured Number
C967797

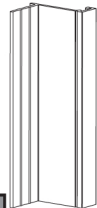

Extrusion Number
5575
Configured Number
C967458

Astragal Cover

2-Wide Doors

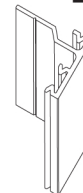

Extrusion Number	Configured Number
5611	C967313

Bottom Sweeps

4-9/16" through 5-7/8" Jamb

5-15/16" through 7-1/8" Jamb

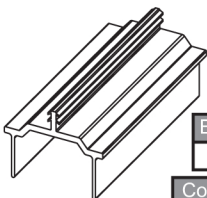

Extrusion Number
5014
Configured Number
C761008

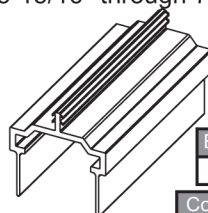

Extrusion Number
5148
Configured Number
C762848

Hinges

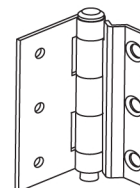

Part Numbers	
White	940016
Adobe	940017
Desert Tan	940018
Hartford Green	940019
Tan	940025

*For finishes not shown, comment when ordering.